

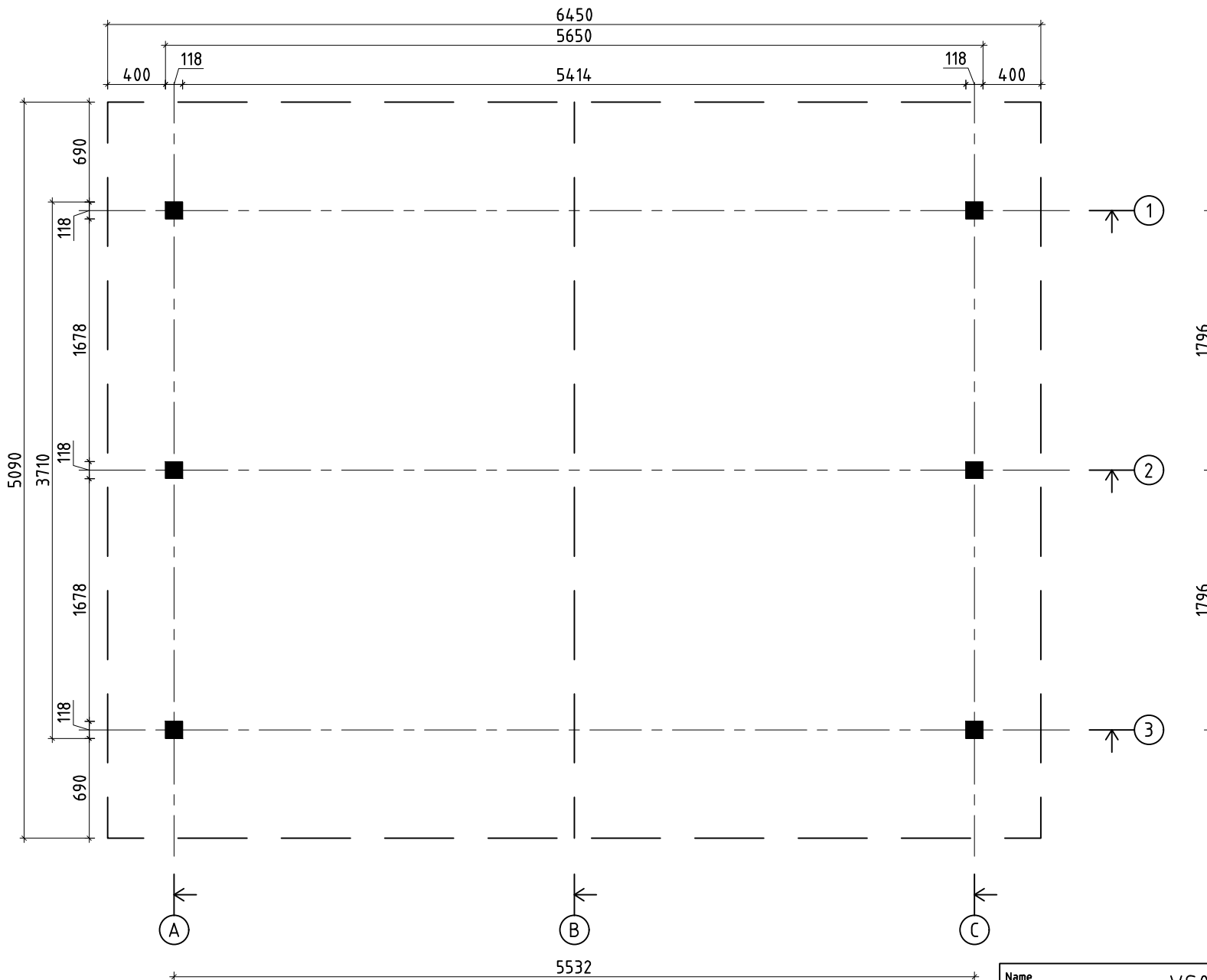

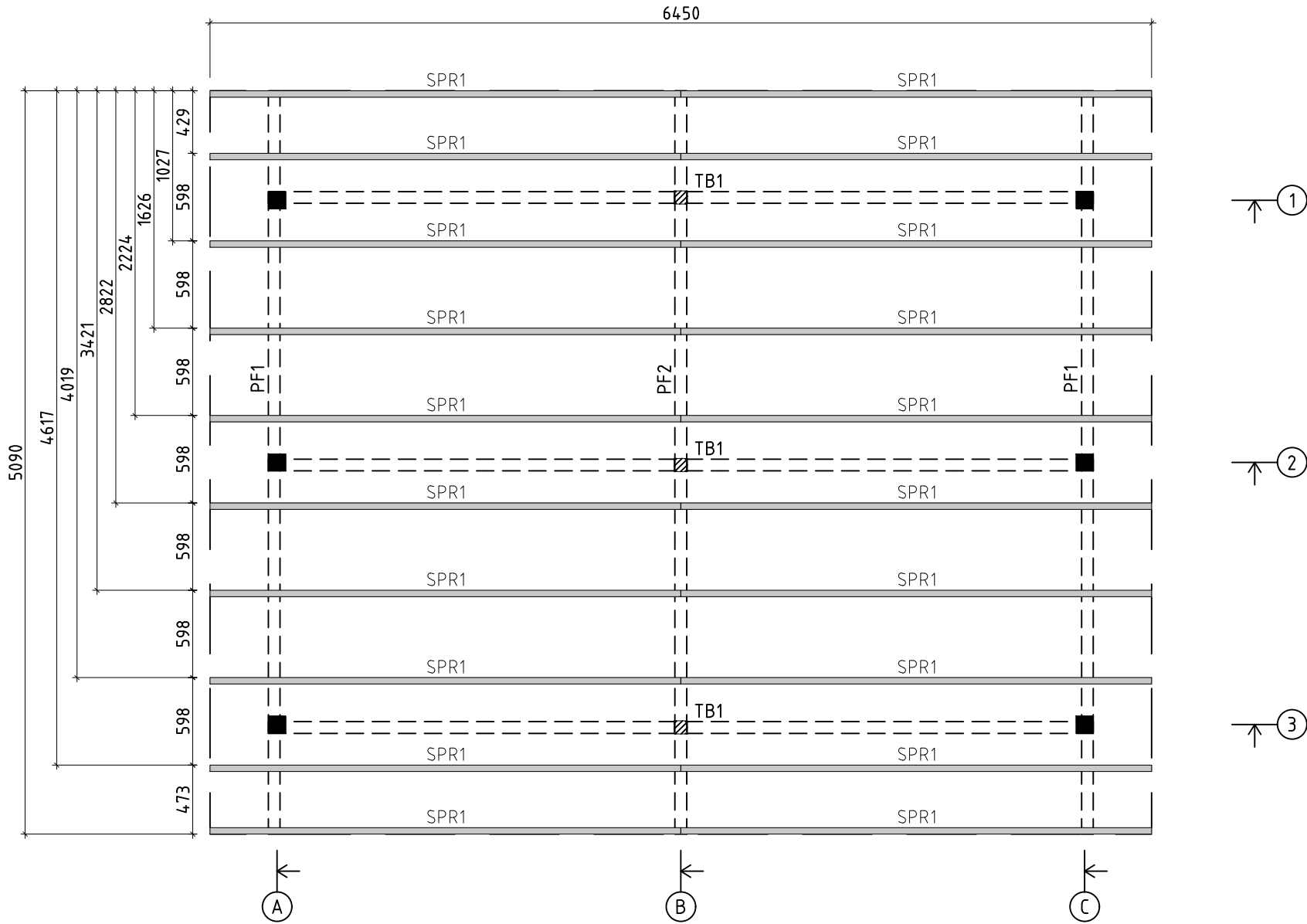





Name	VS00_0068 Carport B 565x371		
Zeichnung/Drawing	3D		
Profil/Profile		Datum/Date	08.02.2024



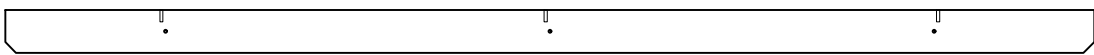
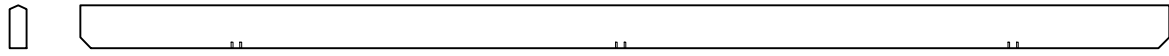
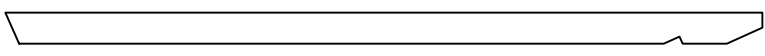
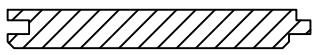
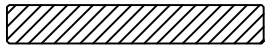
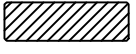
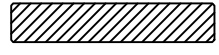
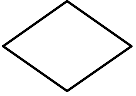
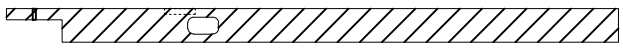
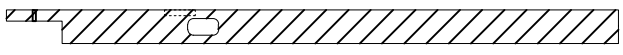
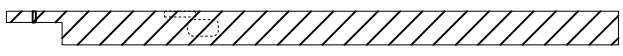
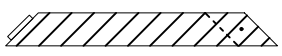
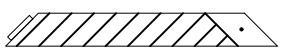
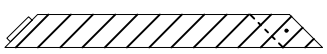
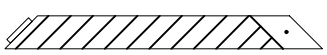
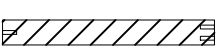
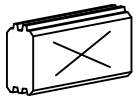

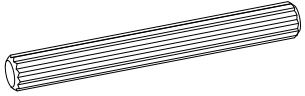

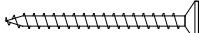

Name	VS00_0068 Carport B 565x371	
Zeichnung/Drawing	Grundplan_Plan	
Profil/Profile	Datum/Date	08.02.2024

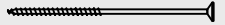



Name	VS00_0068 Carport B 565x371		
Zeichnung/Drawing	Sparren_Rafters		
Profil/Profile		Datum/Date	08.02.2024

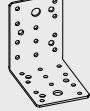

Pos	Teileliste/Specification VS00_0068 Carport B 565x371		Stck Pcs.	Profil Profile (mm)	Länge Length (mm)
TB1	TRÄGEBALKE - SUPPORT BEAM 		3	80x280	5650
PF1	PFETTEN - PURLINS 		2	80x200	5090
PF2	PFETTEN - PURLINS 		1	80x200	5090
SPR1	SPARREN - RAFTERS 		20	44x145	3539
	DACHBRETTER - ROOF BOARDS 			135x18	324,0 lfm/rm
G02-1	GIEBELBRETTER - GABLE BOARDS 18x120 24,3°  ✓		4	18x120	3619
G06-1	GIEBELDECKLEISTEN - GABLE COVER STRIPS 18x58  ✓		4	18x58	3619
T01-1	TRAUFENBRETTER - EAVES BOARDS 18x95 		2	18x95	5090
GS	GIEBELSEGMENT - GABLE DIAMOND 		2		
TP120 -1	STÜTZPFOSTE - SUPPORT POST 120x120 		2	120x120	2200
TP120 -2	STÜTZPFOSTE - SUPPORT POST 120x120 		2	120x120	2200
TP120 -3	STÜTZPFOSTE - SUPPORT POST 120x120 		2	120x120	2200
TP120 -4	STÜTZPFOSTE - SUPPORT POST 120x120 		4	120x120	1000
TP120 -5	STÜTZPFOSTE - SUPPORT POST 120x120 		4	120x120	1000
TP120 -6	STÜTZPFOSTE - SUPPORT POST 120x120 		3	120x120	1165
TP120 -7	STÜTZPFOSTE - SUPPORT POST 120x120 		3	120x120	1165
TP90 -1	STÜTZPFOSTE - SUPPORT POST 90x90 		3	90x90	761
SH	SCHLAGHÖLZER - MOUNTING PIECES 		3		
PT01	Holzdübel - Wood dowel M8x50 TB1 > TP90-1 > PF2 		12		
PT02	Holzdübel - Wood dowel M12x100 PF1 > TB1 		6		
BFP	Befestigungsplatten für Sparren - Mounting plate for rafters 		10		
W04	Winkel - Angle bracket 90x40x40 SPR1 > PF1 		20		
W05	Winkel - Angle bracket 90x90x65 TB1 > PF1 		12		
NG04	NÄGEL - NAILS 2.5x50 Dachbretter - Roof boards 		1188		
SR37	Schrauben - Screws 3.5x45 Giebelbretter - Gable boards Giebelsegment - Gable diamond Traufbretter - Eaves boards 		70		
Kood	VS00_0068 Carport B 565x371		Materjal		Leht 1/2

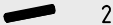
SR63		2
BFP		1
SS542		2

PT02		1
W05		2
SR52		32

PT01		2
------	---	---

SS522		1
-------	---	---

W04		1
SR52		8
SS512		1

SS212		1
-------	---	---

SS532		1
-------	---	---

Name	VS00_0068 Carport B 565x371		
Zeichnung/Drawing	3D		
Profil/Profile			Datum/Date 08.02.2024

1

SS532

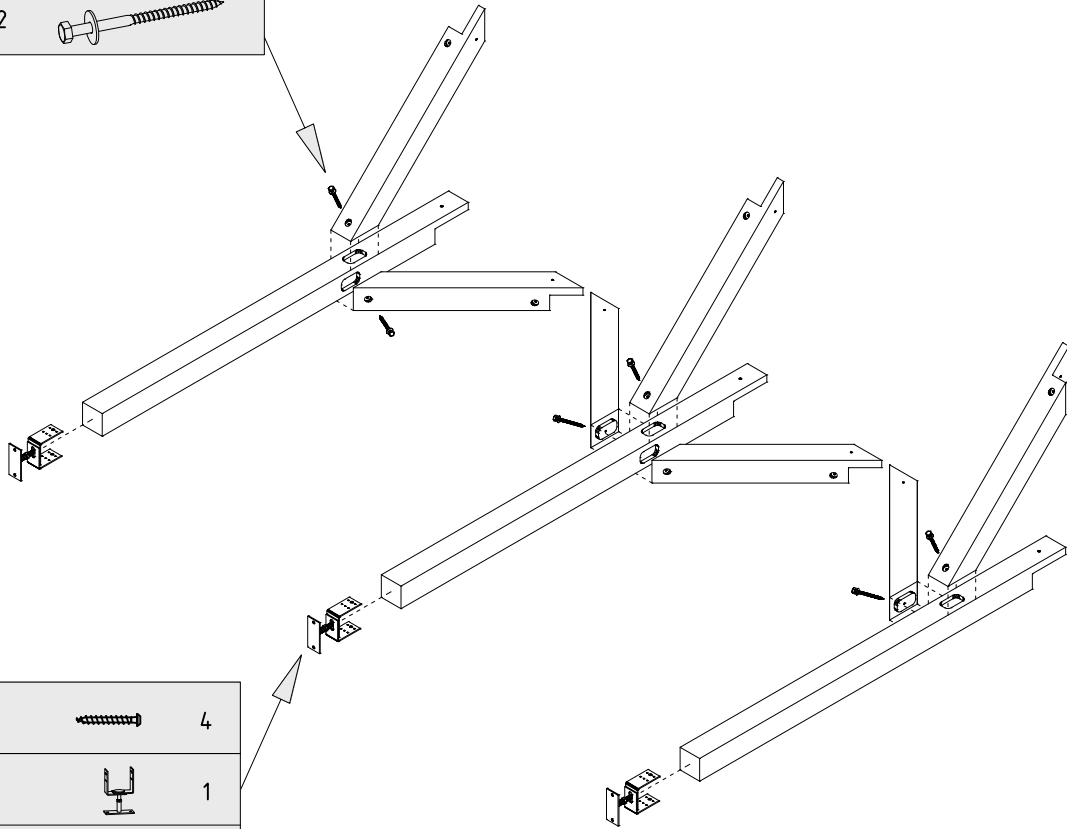

SR52



4

BH01



1

SS542



1

2

SS522

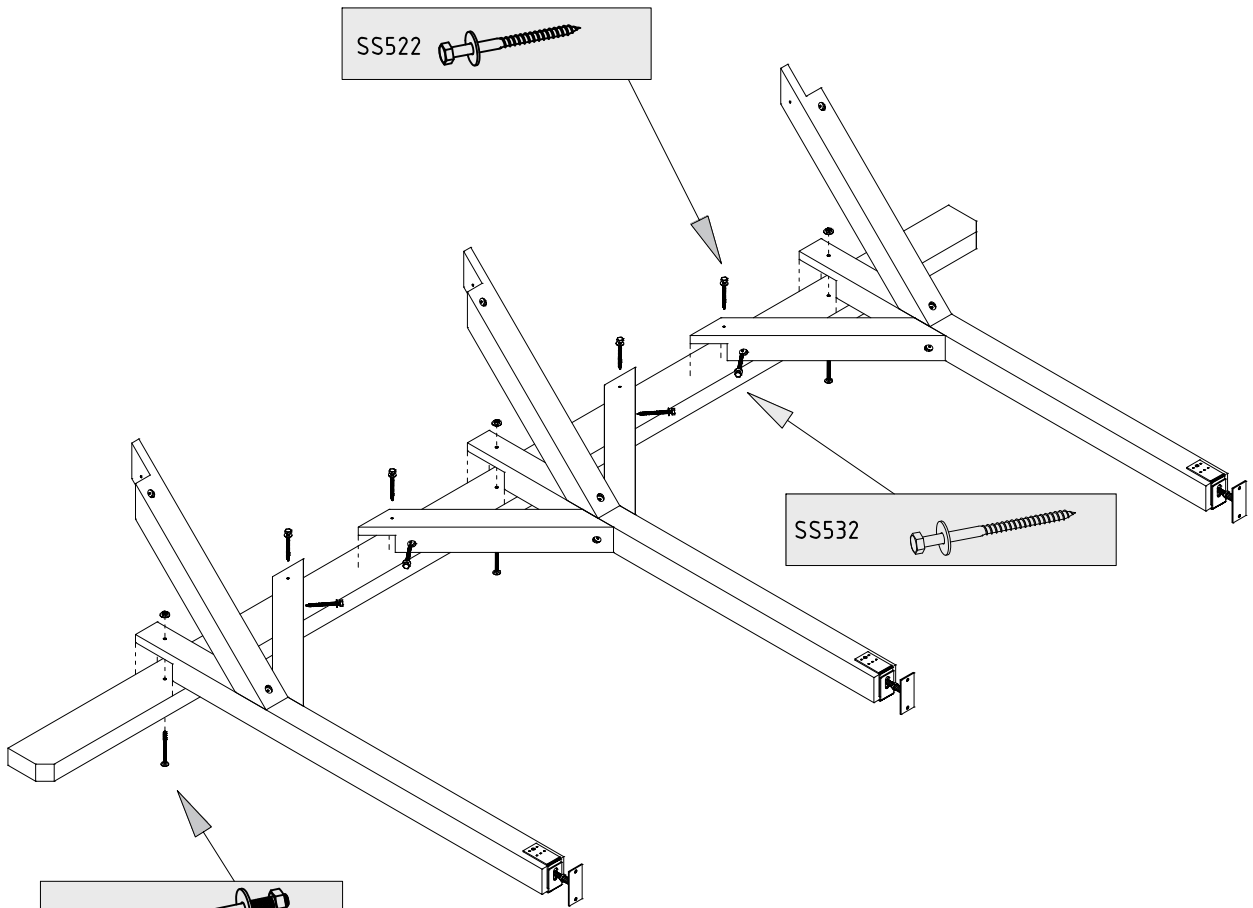

SS532



SS212

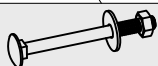

3

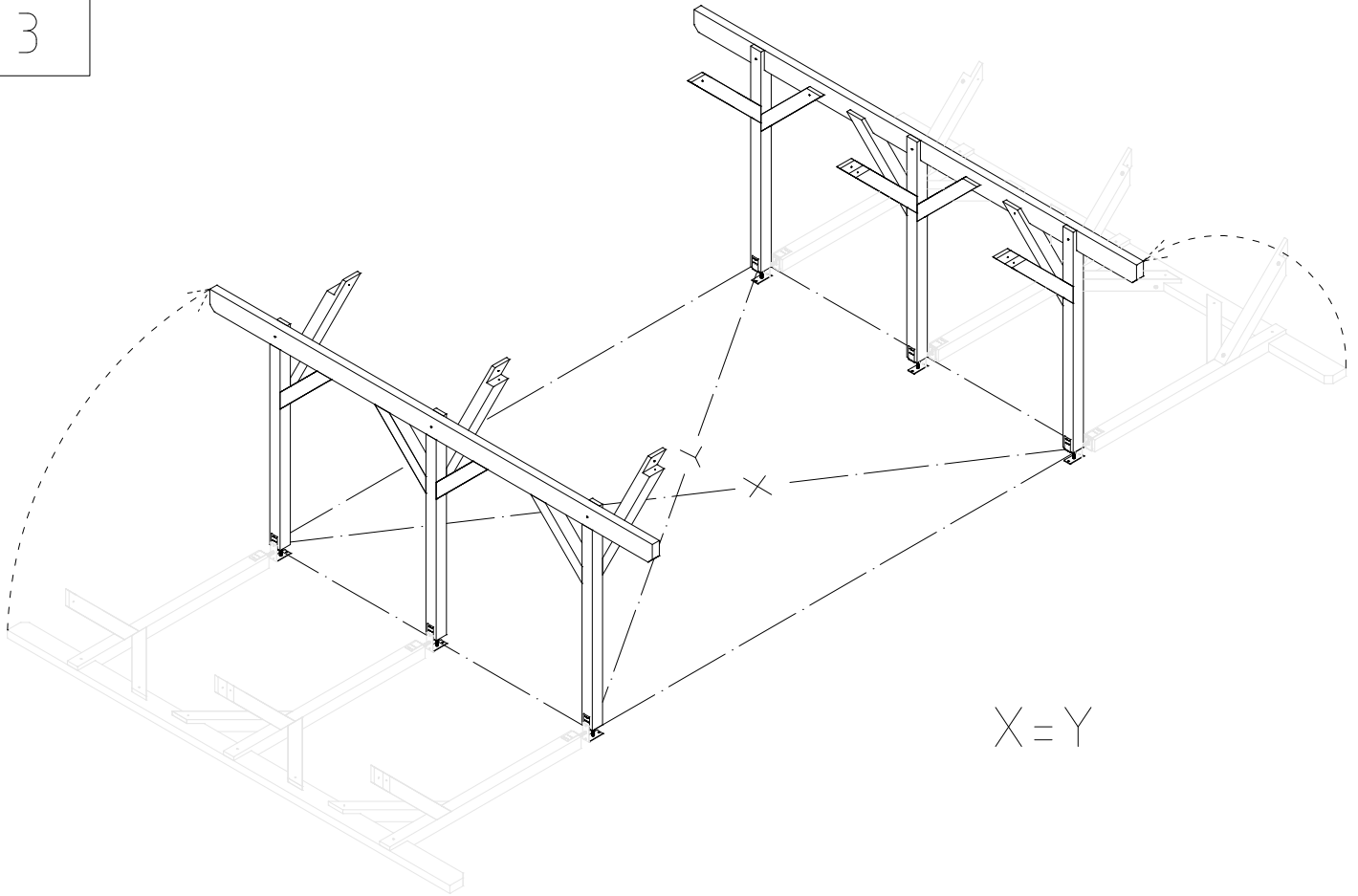

NB! Unterstützung bei Bedarf / Support when needed / Vajadusel toestage

4

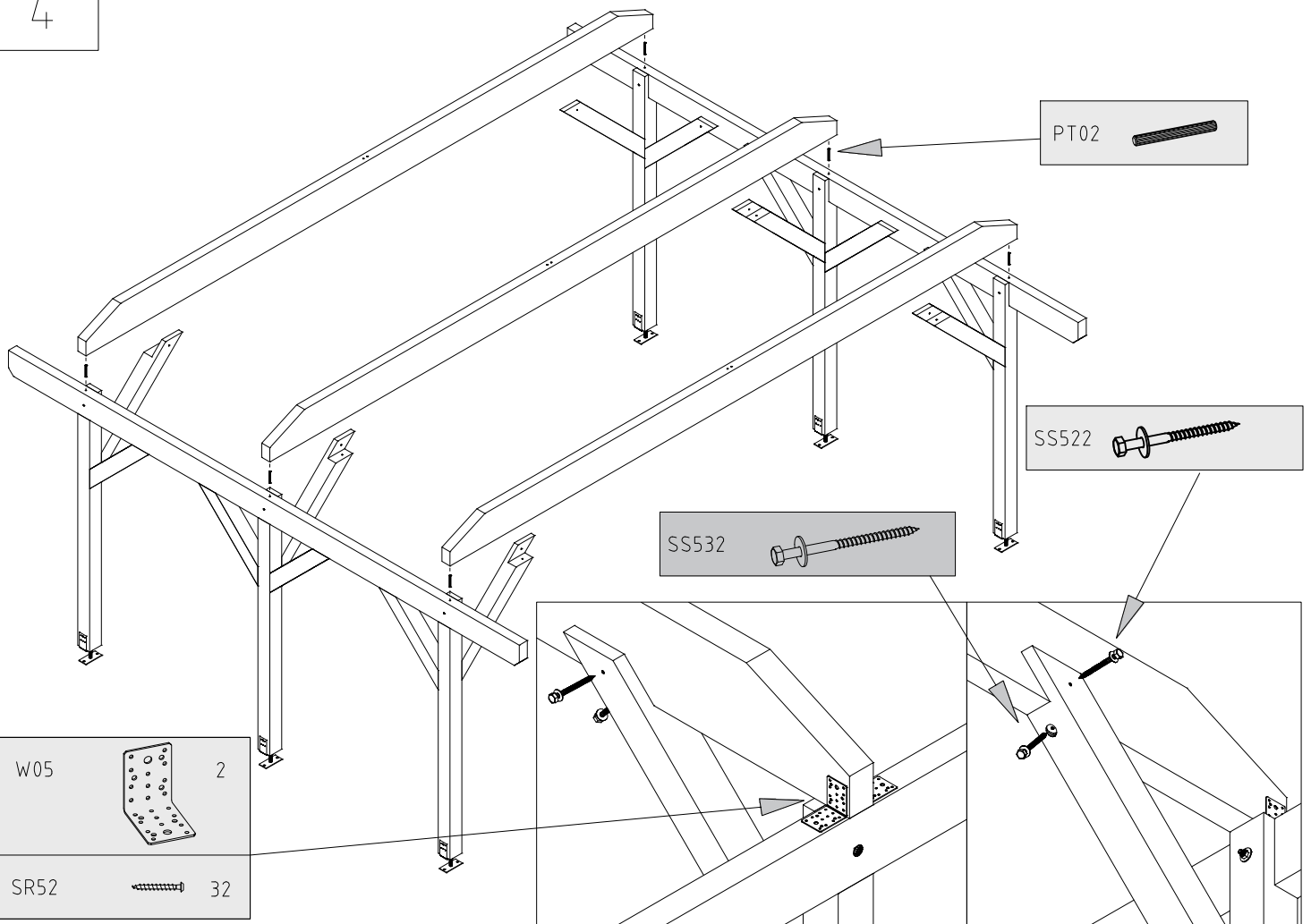

5

PT01

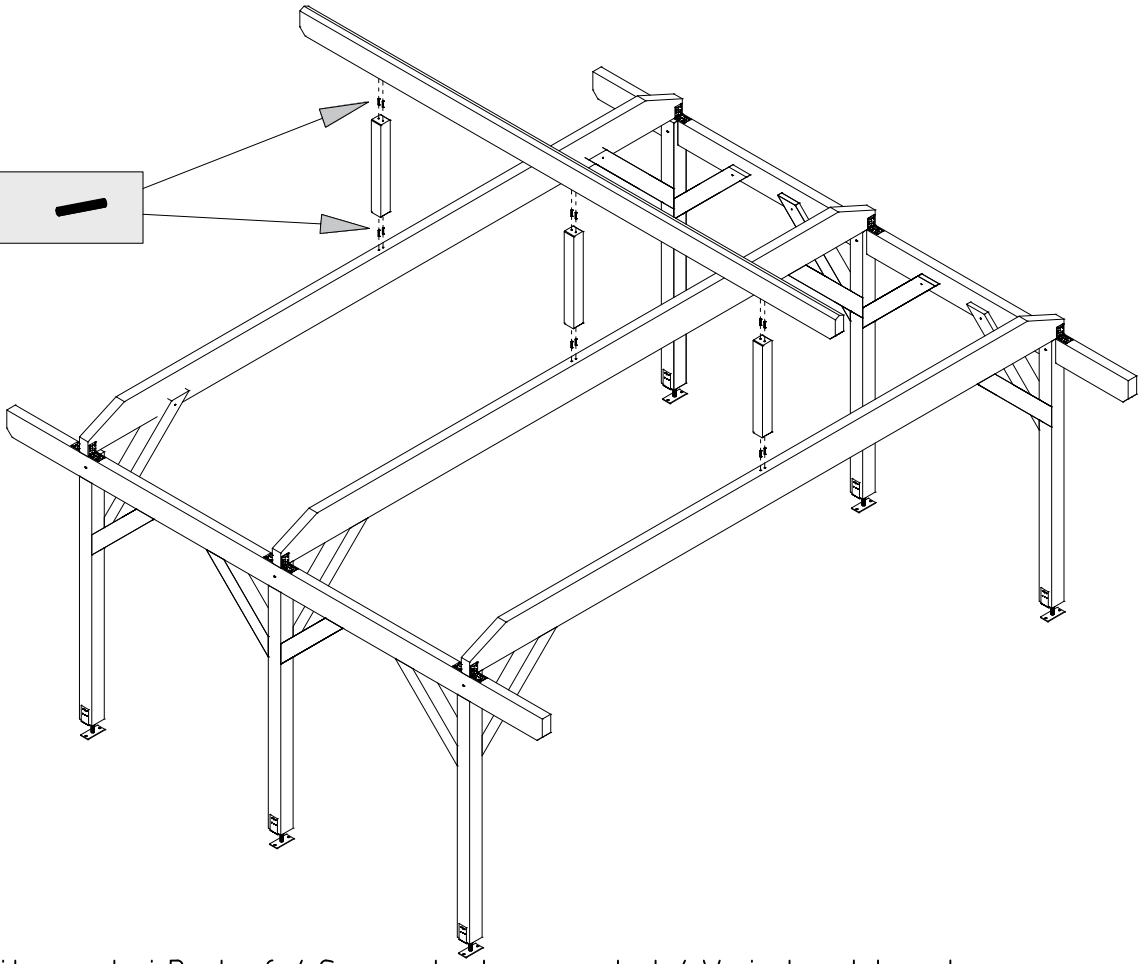

NB! Unterstützung bei Bedarf / Support when needed / Vajadusel toestage

6

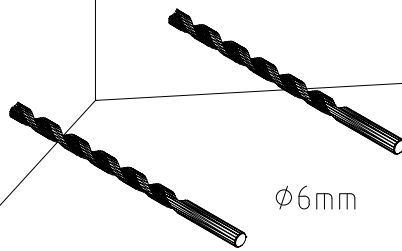

NB! Bohren Sie ein Loch vor / Predrill a hole / Puurige auk ette

7

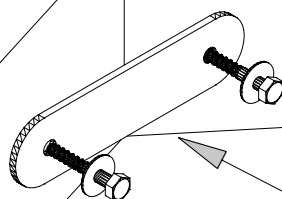

BFP

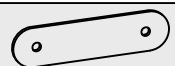

SS542



8

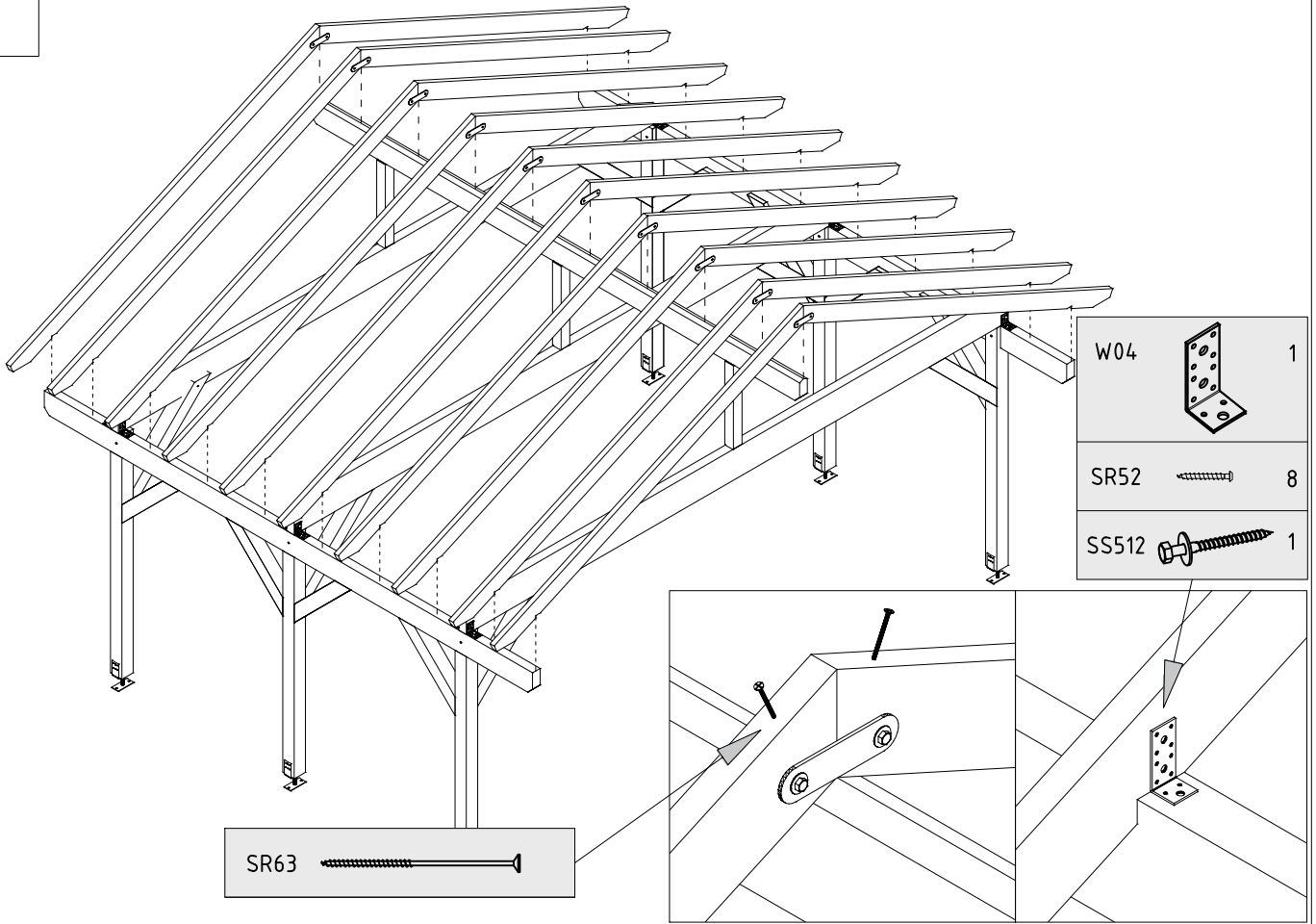

9

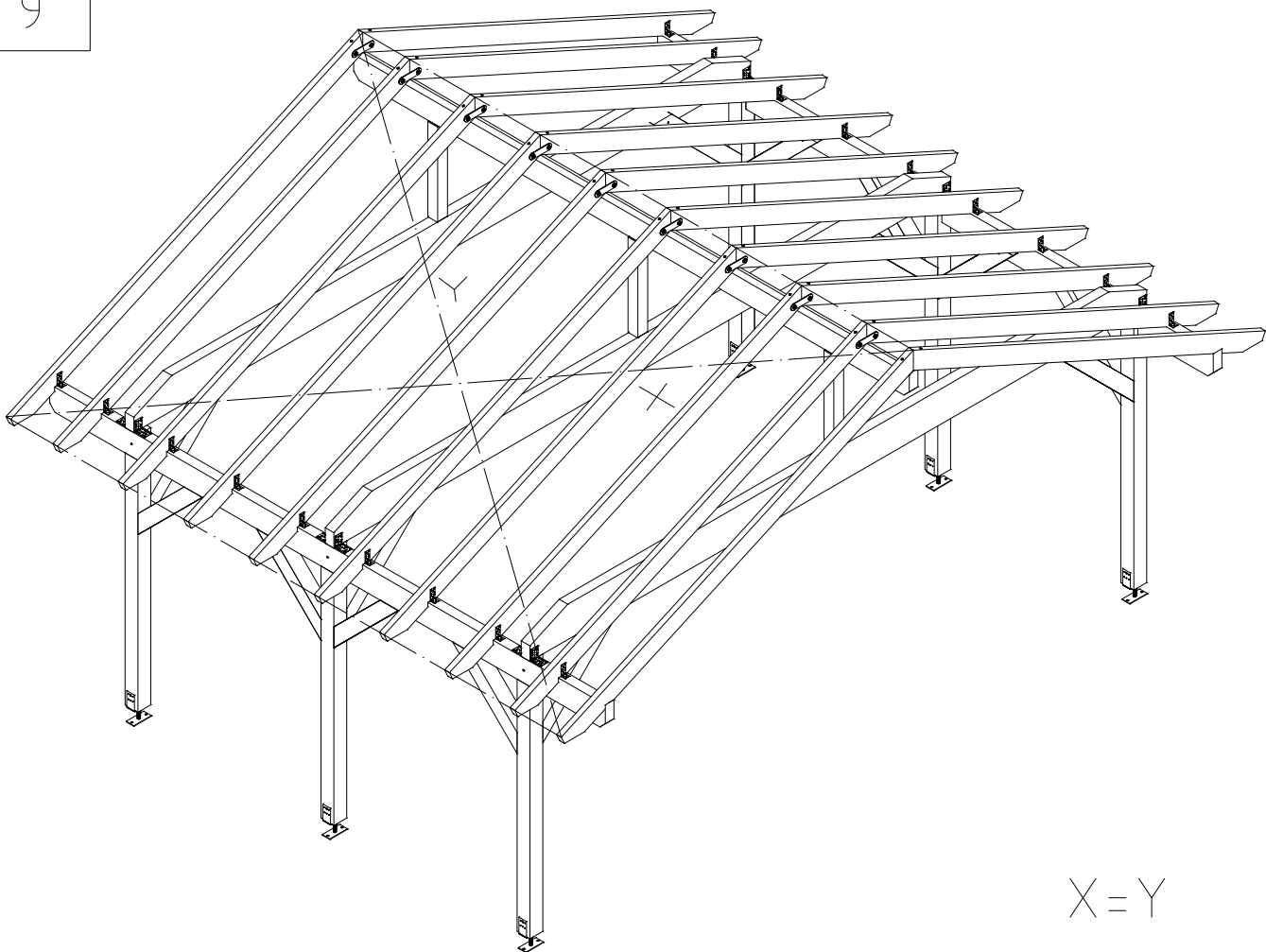

X=Y

10

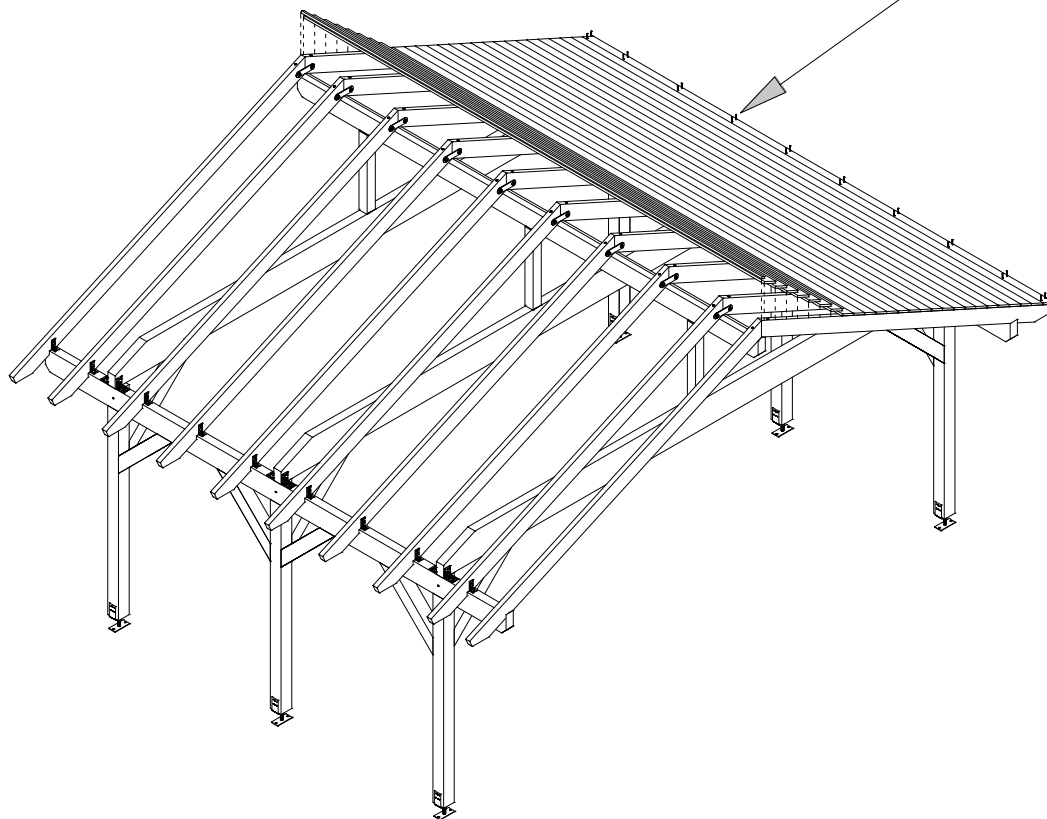

11

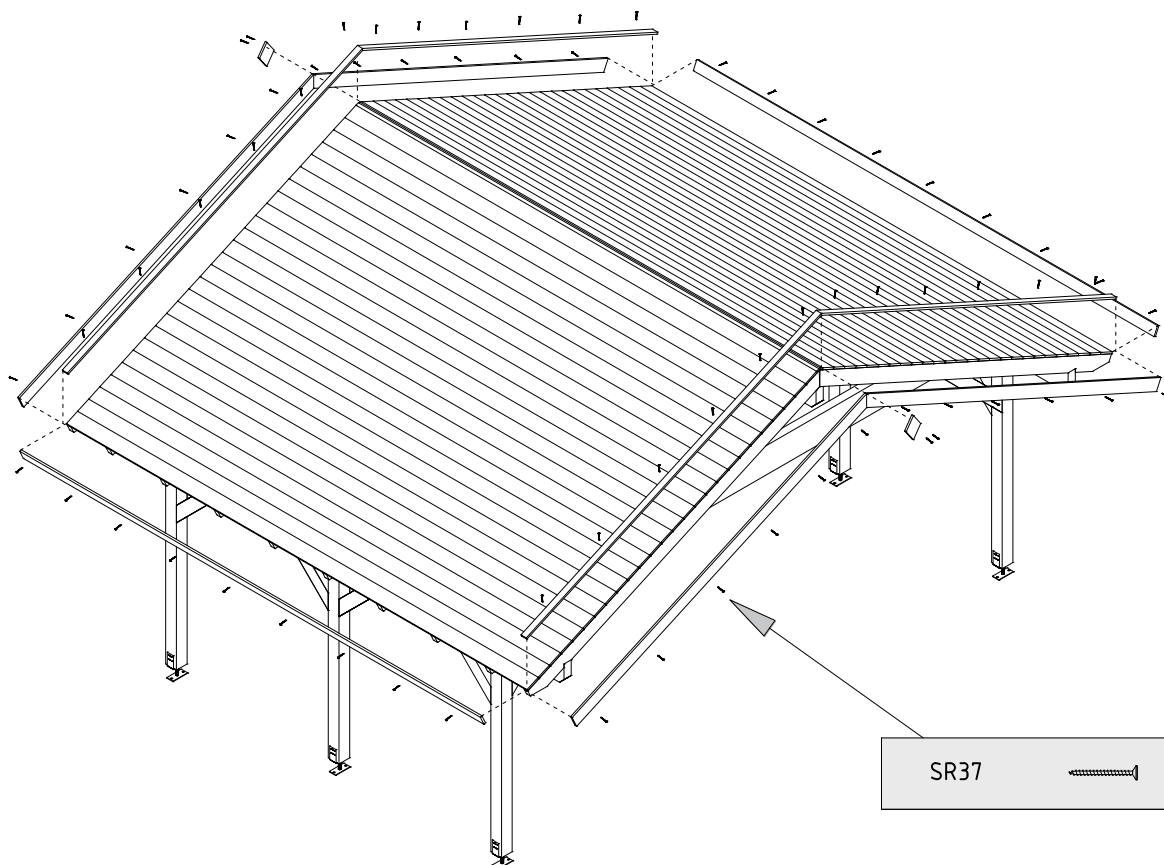

NB! Spannen Sie die Holzschrauben innerhalb einer Woche nach!

NB! Tighten the Bolts within a week!

NB! Nädata jooksul pingutada poldid üle!

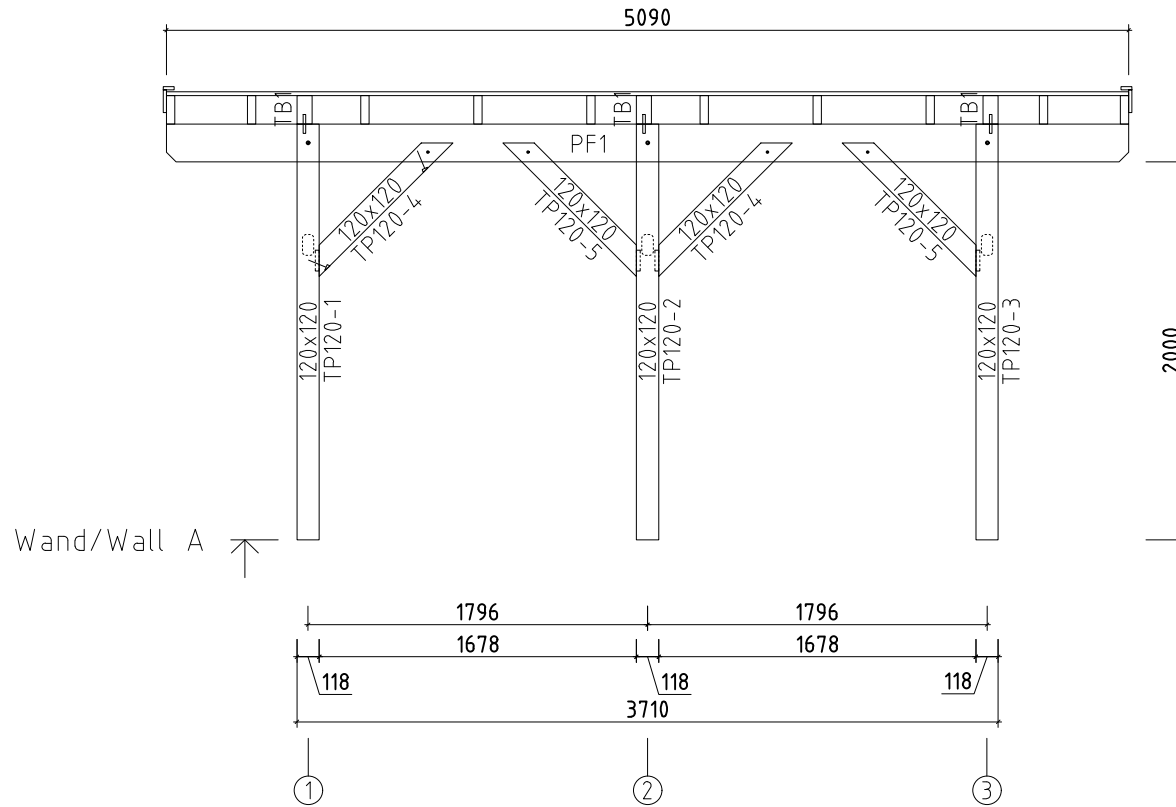
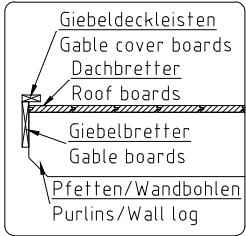

Name	VS00_0068 Carport B 565x371		
Zeichnung/Drawing	WAND/WALL A		
Profil/Profile	5.8x13.5	Datum/Date	08.02.2024

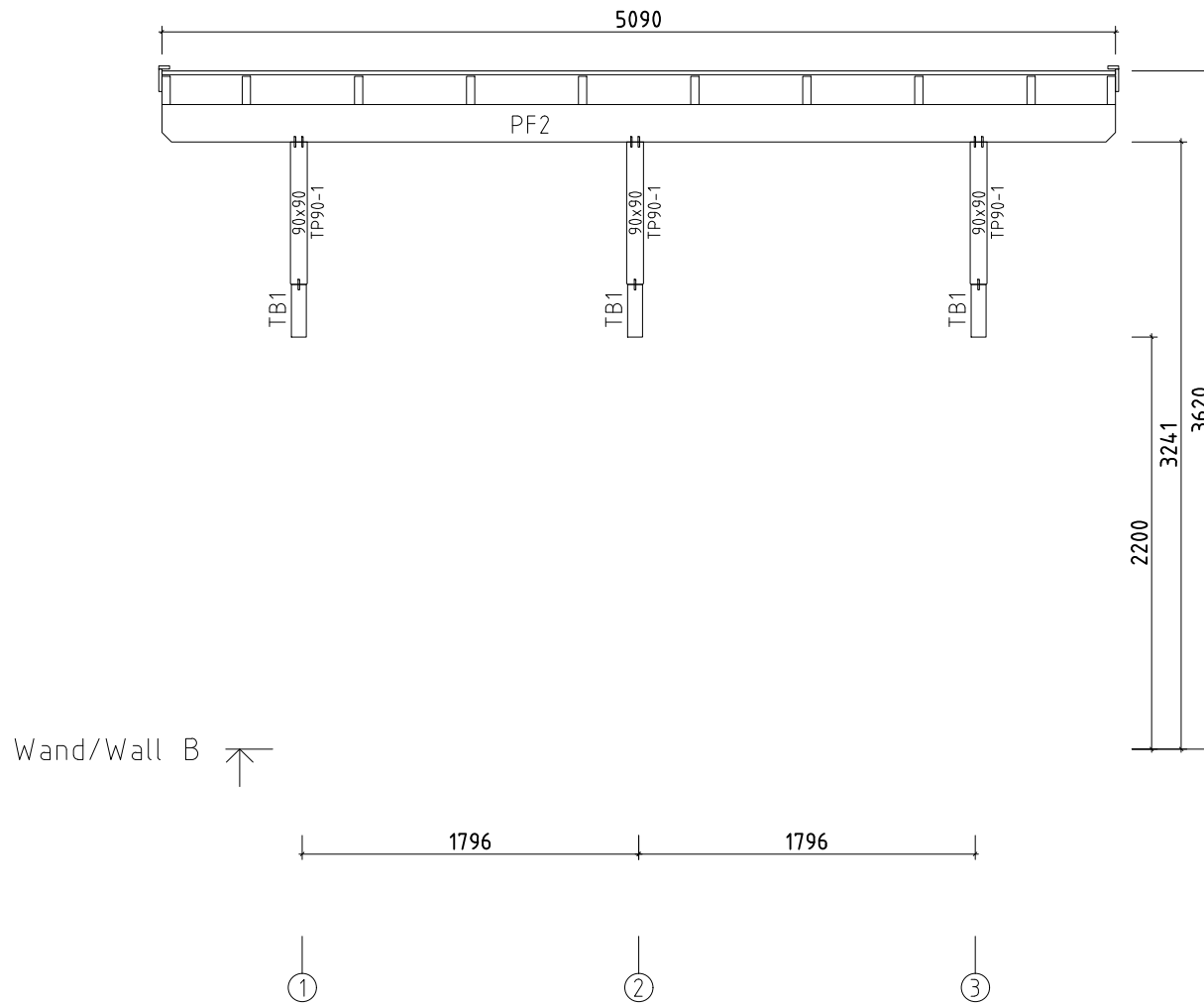

Name	VS00_0068 Carport B 565x371		
Zeichnung/Drawing	WAND/WALL B		
Profil/Profile	5.8x13.5	Datum/Date	08.02.2024

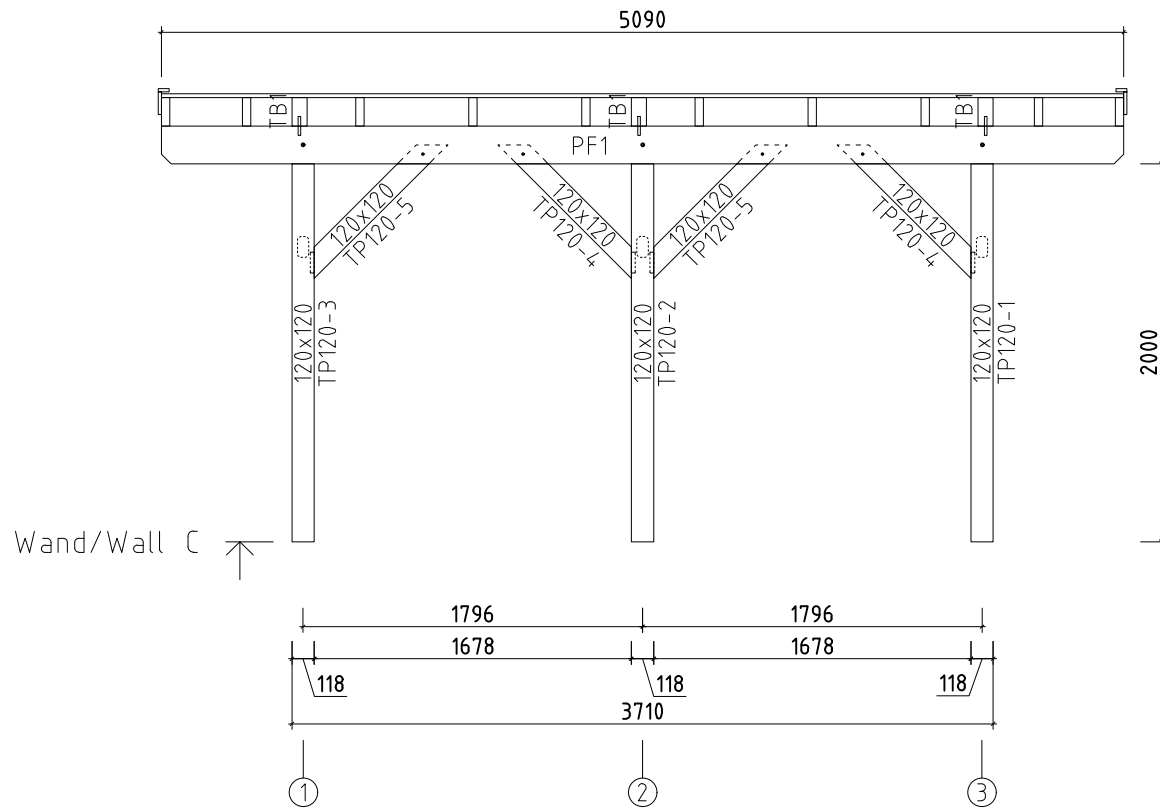

Name	VS00_0068 Carport B 565x371		
Zeichnung/Drawing	WAND/WALL C		
Profil/Profile	5.8x13.5	Datum/Date	08.02.2024

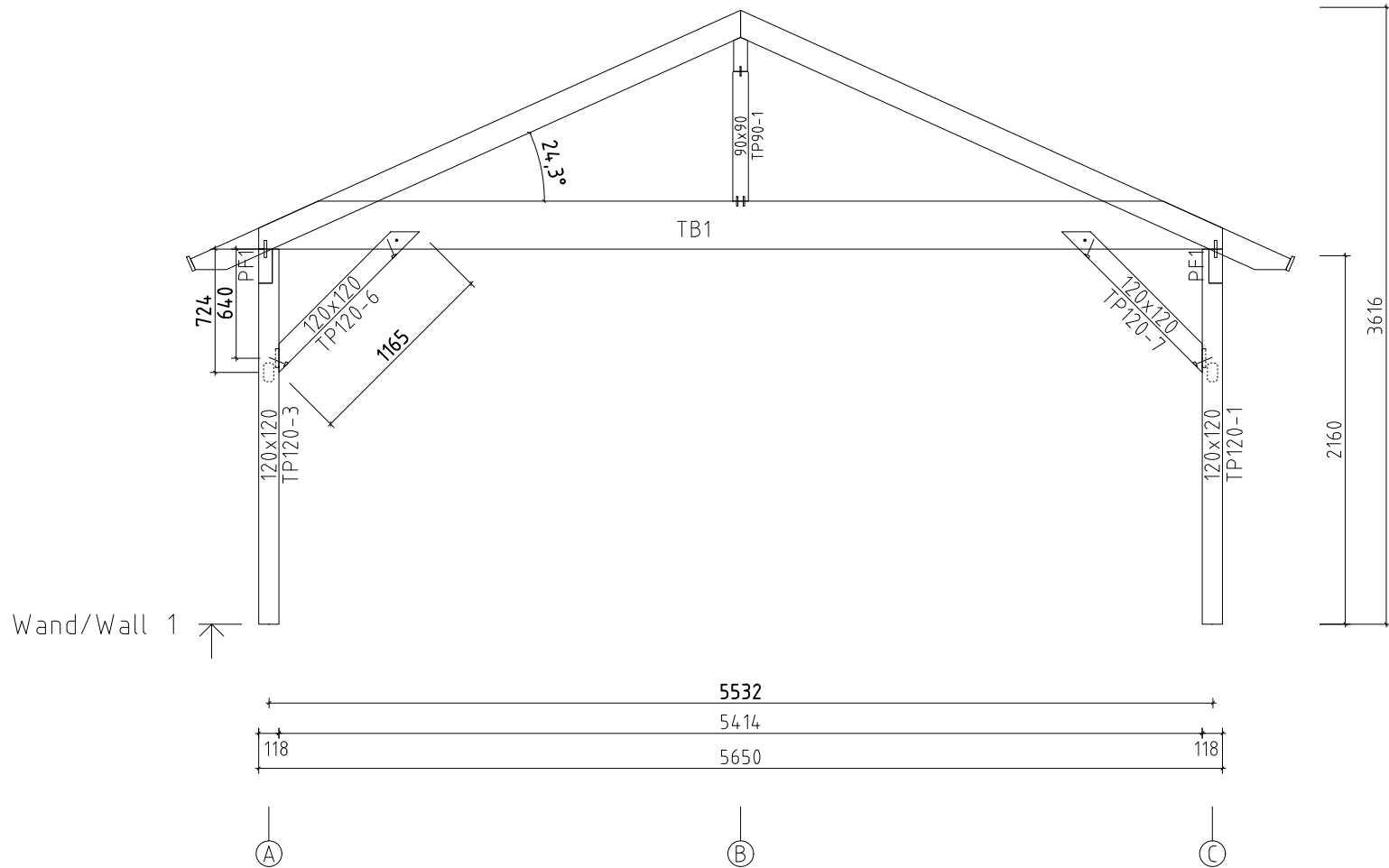

Name	VS00_0068 Carport B 565x371		
Zeichnung/Drawing	WAND/WALL 1		
Profil/Profile	5.8x13.5	Datum/Date	08.02.2024

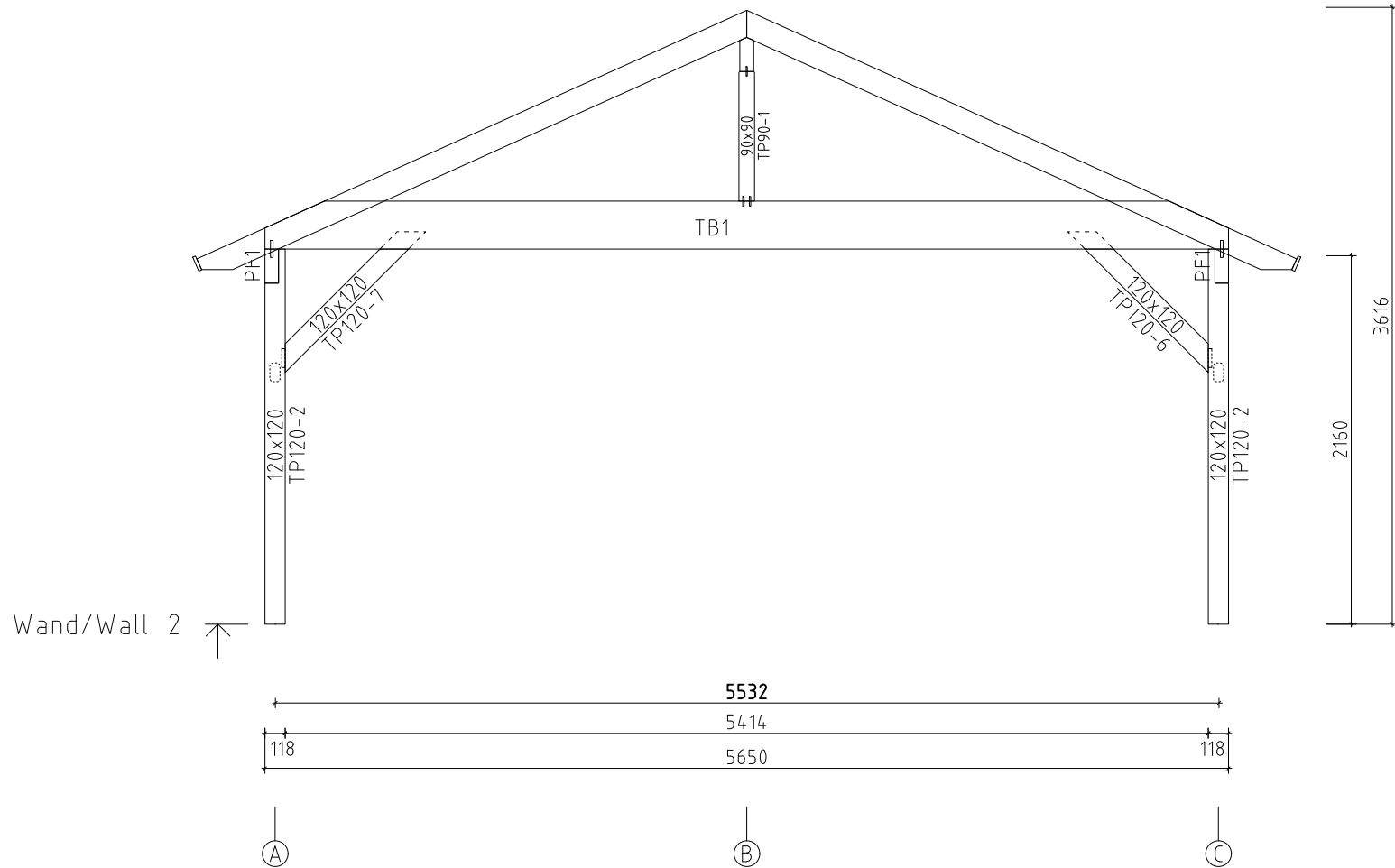

Name	VS00_0068 Carport B 565x371		
Zeichnung/Drawing	WAND/WALL 2		
Profil/Profile	5.8x13.5	Datum/Date	08.02.2024

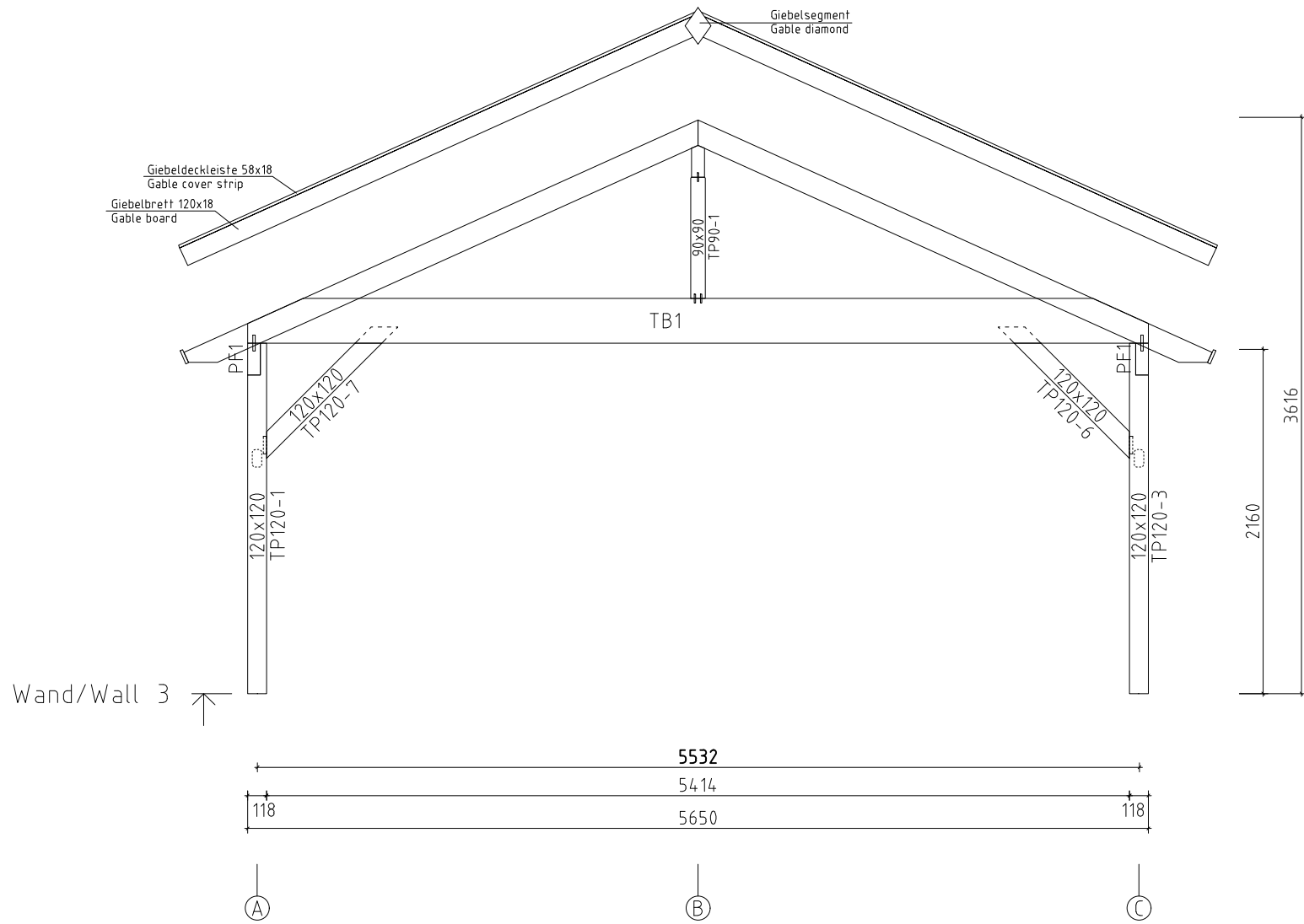

Name	VS00_0068 Carport B 565x371		
Zeichnung/Drawing	WAND/WALL 3		
Profil/Profile	5.8x13.5	Datum/Date	08.02.2024